

Data Sheet



Article number: 021400700022

Description: Sealing Clamp S 22 W5

Measures

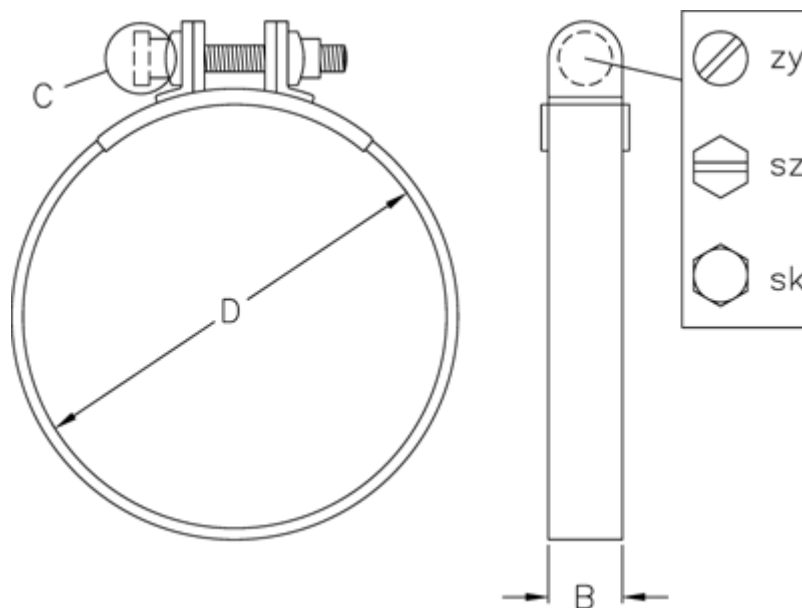

C (screw type) = SZ

Diameter D = 22

Width B = 15